

inch

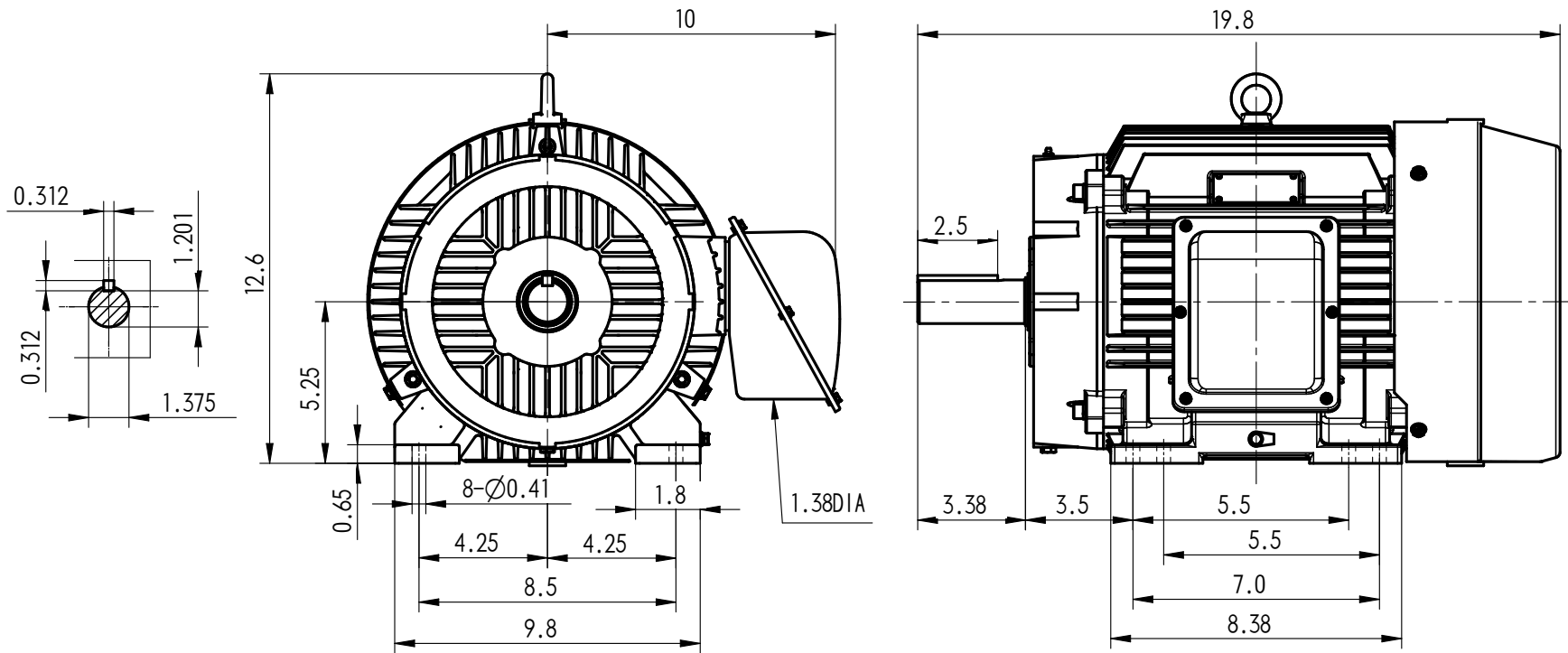

FRAME **215T Footed**