

inch

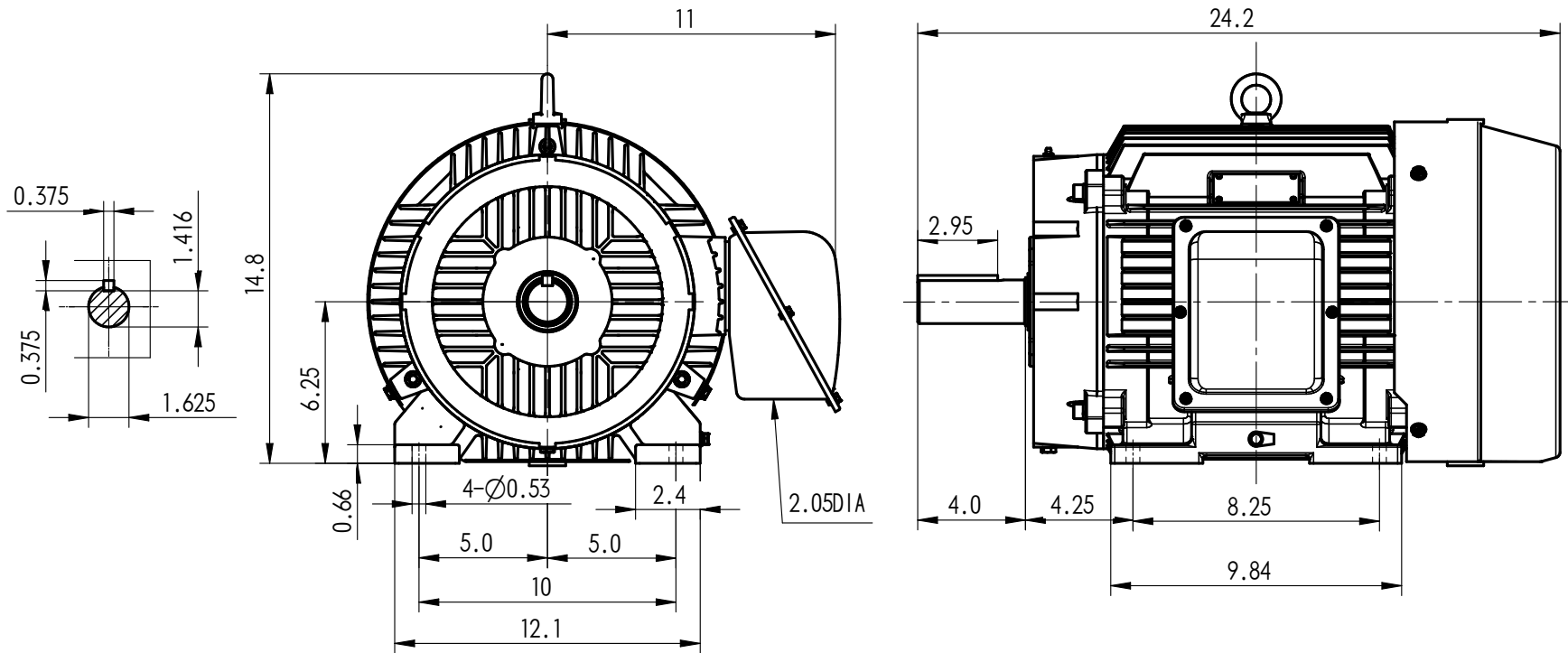

FRAME **254T Footed**