

inch

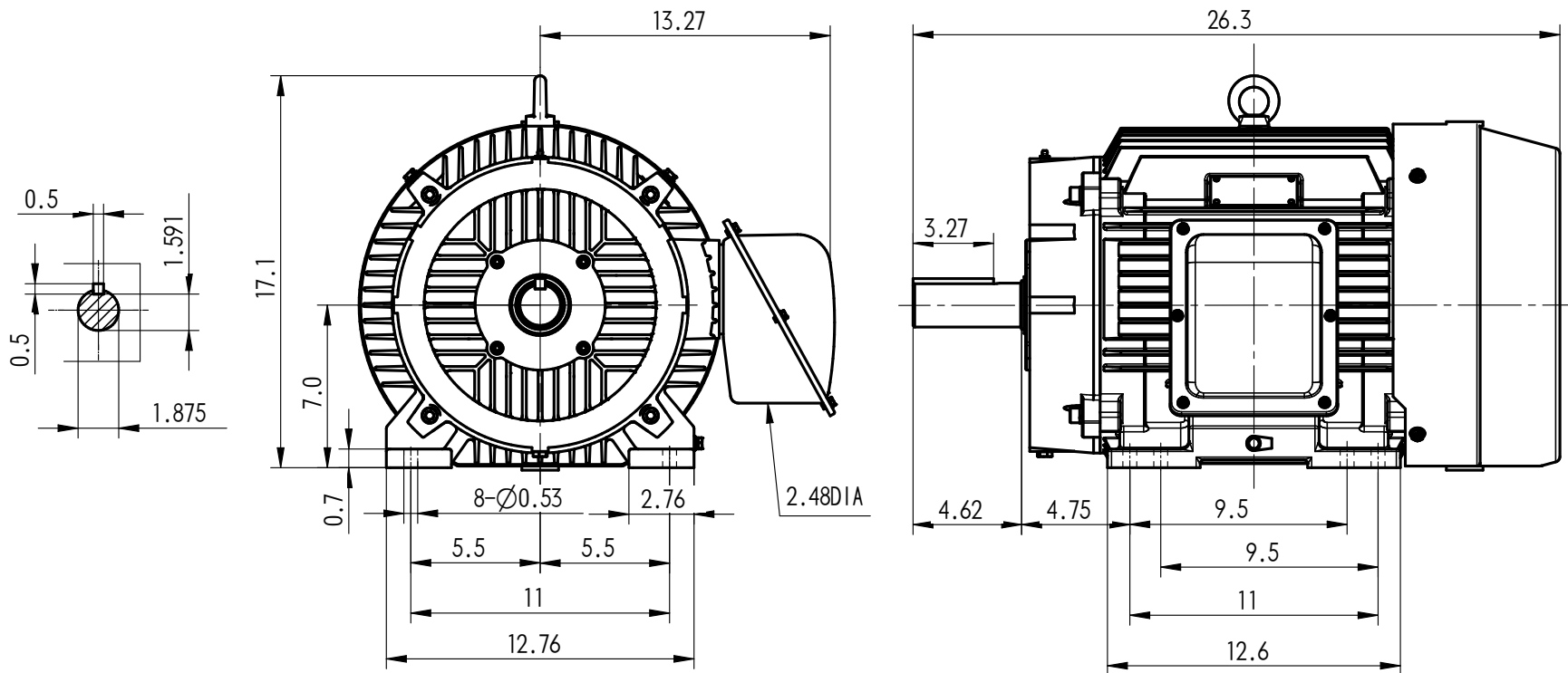

FRAME **286T Footed**