

inch

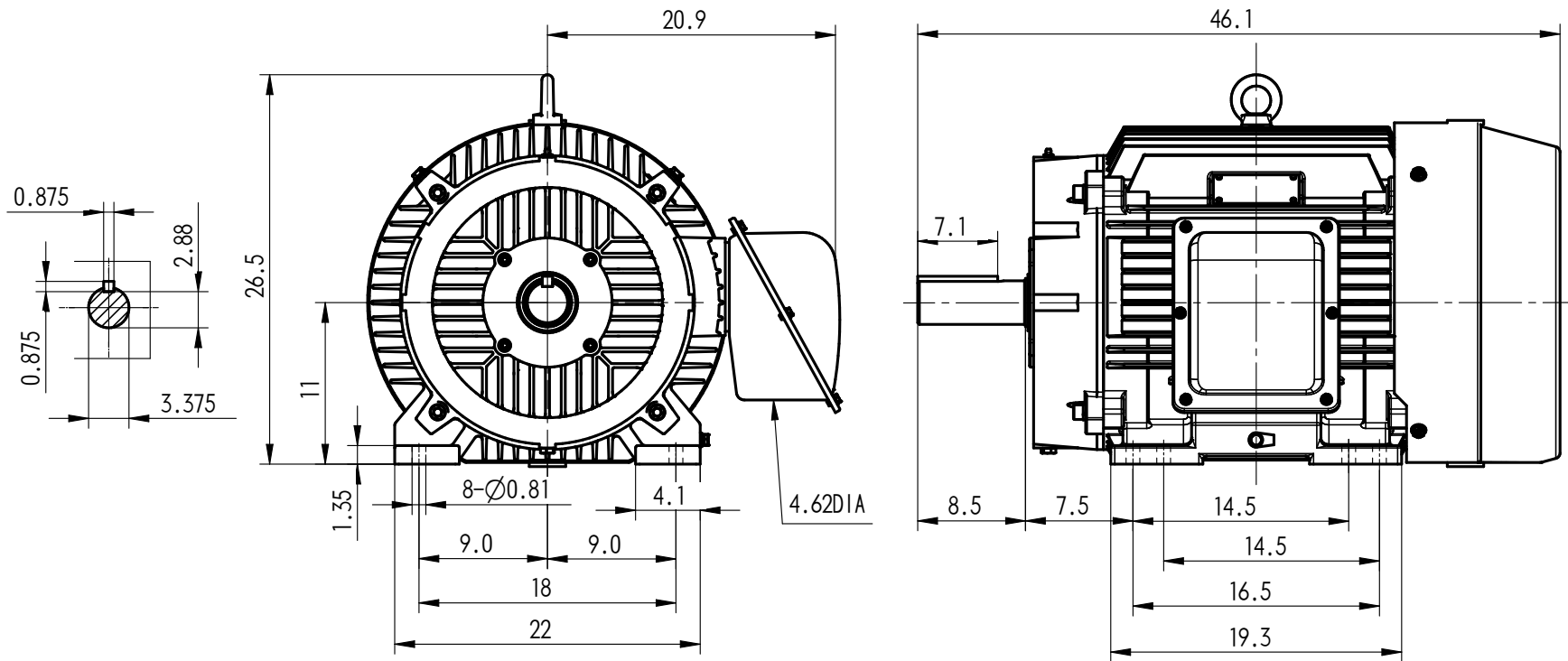

FRAME **445T Footed**